



Product Information

Filters for Instrumentation & Gas Analysis

Tel: +49 (0) 6232 24021

Fax: +49 (0) 6232 24025

Email: info@headlinefilters.de

Website: www.headlinefilters.de



Leading Brand

Headline Filters is Europe's premier manufacturer of filter elements and housings for the instrumentation and gas analysis market. Calling on over 30 years experience, Headline Filters has become the industry standard. These filters are suitable for a variety of applications and are used in a wide range of industries throughout the world.

Elements for all applications

Headline disposable bonded microfibre filter elements are extremely efficient, as well as being low cost. The benefits of this type of element are high flow rates with very low pressure drops and long service life. All products conform to industry-standard sizes and grades, allowing Headline elements to be fitted into other manufacturers' housings. Stainless steel and PTFE filter elements are also available for applications requiring extreme inertness or high strength.

Extensive housing range

The comprehensive range of filter housings enables greater flexibility for customers, with a wide choice of standard designs in a variety of materials. The development of new products is customer driven, with our engineers working closely with OEM customers and end-users to produce products which exactly meet the specified requirements.

Custom made specials

Special housings and filter elements designed and produced in line with customer requirements and specifications are always available.

Available worldwide

A global distributor network, which includes all of Europe, the USA, Canada and South America, Japan, South East Asia, Australia and South Africa, offers unbeatable delivery times and local customer service.

Other Headline Filter Ranges

Compressed Air



Request bulletin HFL202

Process Gases

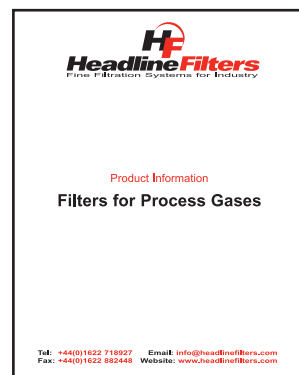

Request bulletin HFL203

Vacuum Pumps

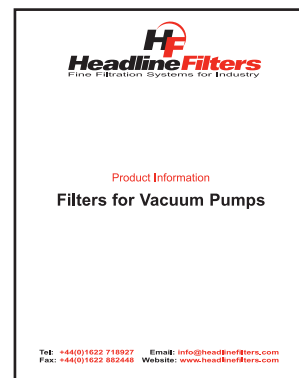

Request bulletin HFL204



Filter Applications

Headline filter housings and elements are suitable for a wide range of gas filtration applications for both particulate removal and coalescing of liquid aerosols.

Filter housing configuration will depend on the filtration duty. Some of the more common applications are shown here.

To select the correct filter housing, the following information is required –

- 1 Pressure and temperature of the gas at the filter housing.
- 2 Chemical & physical composition of the gas.
- 3 Contaminants to be removed.
- 4 Type of filtration duty: Inlet, particulate, coalescing, fast loop.
- 5 Flow rate, line size and level of filtration required.
- 6 Relative importance of cost, response time, ease of service and interval.

Items 1, 2 and 3 will determine the materials of construction of the filter housing, including element and seals. Filter housings are available in a wide variety of materials, to ensure there is a product in the range for even the most specialised applications. As well as our range of standard materials, a wide range of exotic materials is also available to special order.

Item 4 will determine the configuration of the housing, one port for inlet filters, 2 ports for in-line housings and 'T' housings for particulate filtration, and three ports for coalescing or fast loop housings.

Items 5 and 6 will establish the most appropriate size of filter. This is always a compromise between those factors favouring a small filter (fast response time, smallest space requirement, lowest cost, minimised adsorption losses) and those factors favouring a large filter (long service intervals, low pressure drop). The exact choice will therefore depend on the relative importance of these factors in each particular application.

Headline Filters representatives have a vast experience of specifying successful installations and we will be pleased to help you select the best solution to your filtration problem.

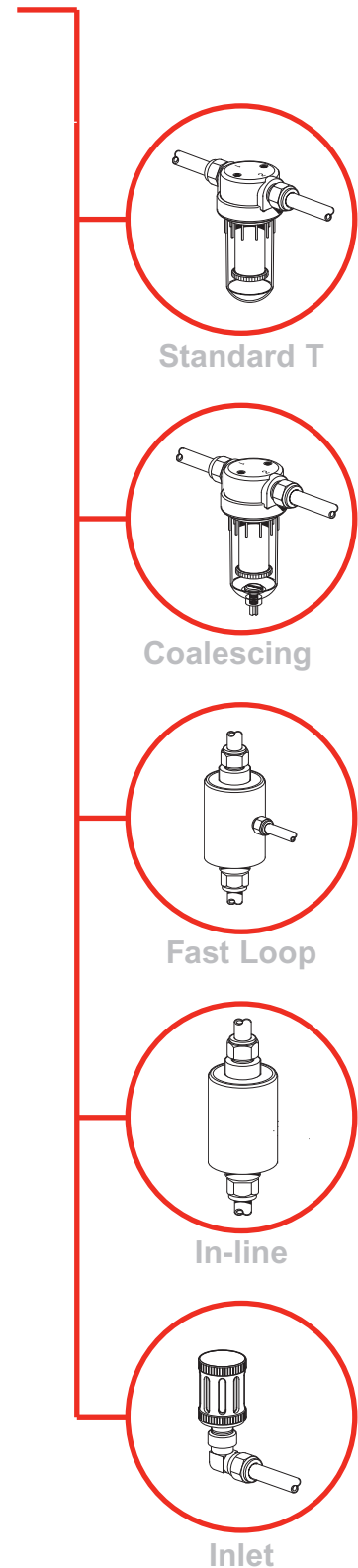

Disposable Bonded Microfibre Filter Elements

Headline disposable filter elements are manufactured from precise mixtures of borosilicate glass microfibres, to the very highest standards of quality control. These elements offer exceptional filtration efficiency at very low pressure drops and, being 90+% void volume, give very long service life.

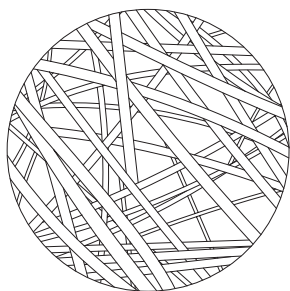

The elements are self-gasketing and easily sealed into the housing by axial compression.

The elements are bonded to impart high strength and eliminate fibre shedding. The choice between the different binders available will depend upon the application conditions.

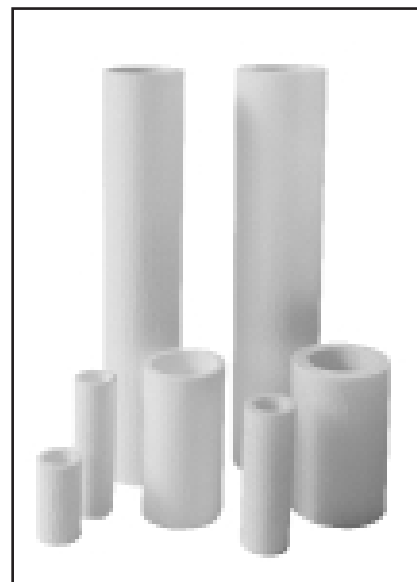

Particulate Removal Applications

Standard elements are suitable for all particulate removal applications in non-corrosive gases. The coarsest grade that will adequately protect the application should be chosen, as this will result in the most economical solution to the contamination problem.

K Type are specified where corrosive gases and liquids are to be filtered, as they have excellent chemical resistance. They are also used where highly reactive gases are being analysed, since they exhibit very low levels of adsorption.

S Type are completely inorganic and are used at temperatures up to 500°C or if solvents are present.

Coalescing Aerosol Removal Applications

C Type elements are specifically designed for the removal of liquid aerosols from gases in both corrosive and non-corrosive applications. These elements also remove particulates with the same efficiency.

Filter Element Efficiency

Each element type is available in a wide range of grades of efficiency, covering the complete range from coarse bulk contamination removal (grade 80) and the essentially complete removal of submicron particles (grade 40).

Principal Specifications

Element Type	For removal of	Binder Type	Max. Temp.	Grade designations, removal of 0.1 micron particles				
				99.9999+%	99.99+%	99.5+%	95+%	75+%
Standard	solid particulate	Epoxy Ester	150°C	40	50	60	70	80
K Type	solid particulate	PVDF Fluorocarbon	150°C	40K	50K	60K	70K	80K
S Type	solid particulate	Silica Inorganic	500°C	40S	50S	60S	70S	80S
C Type	liquid aerosols	PVDF Fluorocarbon	150°C	-	50C	60C	70C	80C

Filter Element Dimensions

All disposable filter elements have a part number arranged with three figures, e.g. 25-64-70C. The first part refers to the inside diameter of the element in millimetres, the second figure refers to the overall length of the element in millimetres and the third part refers to the grade designation. Replace the 'xx' in the part numbers listed below with the grade designation.

Standard Sizes

12-32-xx	12-57-xx
25-64-xx	25-127-xx
25-178-xx	38-58-xx
38-152-xx	45-127-xx
51-89-xx	51-230-xx
51-476-xx	63-762-xx

Special Sizes

Special size filter elements are manufactured in a range of diameters and lengths.

Inside Diameters - 10mm to 100mm
Lengths - 10mm to 1000mm

Please enquire with any specific requirements.

Stainless Steel and PTFE Filter Elements

Stainless Steel Filter Elements

Stainless steel filter elements are made up of several layers of 316 mesh that are sintered together to form an integrated porous element. The middle mesh is of very fine gauge and determines the filtration efficiency of the elements. This layer is then overlaid with inner and outer layers of coarser mesh, to give support and protection.

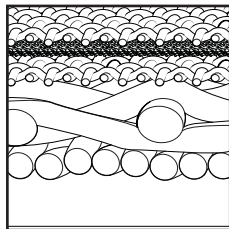

The elements are a typical surface filter and the contaminants are retained on the surface of the filtration layer, this makes cleaning and back flushing a simple process. These filter elements should be ultrasonically cleaned to give best results.

Stainless steel filter elements are particularly useful in heavily contaminated applications and for use as pre-filters before disposable type final filters. Gaskets are required with stainless steel filter elements. The options are Viton, PTFE or high temperature annealed copper.



Standard Dimensions

Grades available - 1µm, 3µm, 10µm, 25µm and 100µm. Replace the 'xx' with the grade, e.g. SS-120-01V

Viton Seals	PTFE Seals	High Temp. Seals	Inside Dia.	Length
SS-110-xxV	SS-110-xxT	SS-110-xxH	12mm	32mm
SS-120-xxV	SS-120-xxT	SS-120-xxH	12mm	57mm
SS-130-xxV	SS-130-xxT	SS-130-xxH	25mm	64mm
SS-140-xxV	SS-140-xxT	SS-140-xxH	25mm	178mm

PTFE Filter Elements

PTFE filter elements are produced by sintering pure PTFE granules, no other substances are used in the construction. These filter elements are usually offered when only 100% pure PTFE can be used. It is normally preferable to offer a K type disposable filter element, if suitable, as both pressure drop and life characteristics are superior to the PTFE elements. The advantage of PTFE is a higher maximum temperature, up to 200°C, and somewhat better chemical resistance. These filter elements should be ultrasonically cleaned to give best results.

Standard Dimensions

Grades available - 3µm, 10µm, 25µm.
Replace the 'xx' with the grade, e.g. PT-120-03

Element	Inside Dia.	Length
PT-110-xx	12mm	32mm
PT-120-xx	12mm	57mm
PT-130-xx	25mm	64mm
PT-140-xx	25mm	178mm

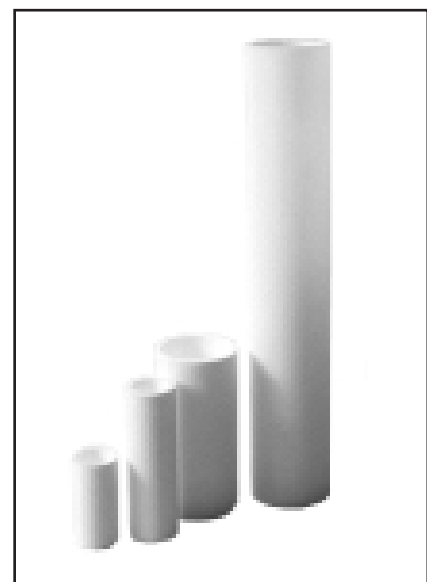

Disposable In-Line Filters

Completely disposable
Easy to install and replace
Choice of housing materials
Excellent chemical resistance
Five grades of filtration

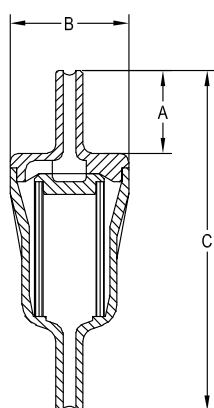
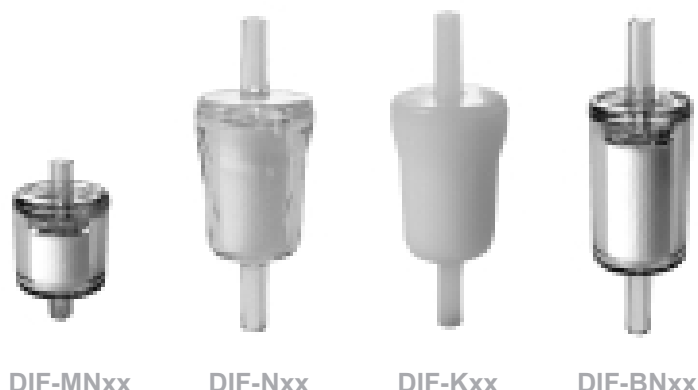

Headline Filters range of Disposable In-Line Filters consists of permanently welded housings with encapsulated filter elements. This makes them ideal for portable analysers and other analysis systems requiring a robust and easily replaceable filter. A choice of body materials makes them suitable for a wide range of chemical environments.

The units on this page are designed for particulate removal applications. For coalescing and bypass filtration duties, the DIF-INxxC, DIF-LNxxC and DIF-LKxxC should be considered. Where running cost is more important than initial cost, plastic housings with replaceable elements should be considered - see pages 22-26.

The 'xx' in the part number should be replaced with the grade required, e.g. DIF-N70, DIF-MN40.

Principal Specifications

Housing Model (1)	DIF-MNxx	DIF-MKxx	DIF-Nxx	DIF-Kxx	DIF-BNxx	DIF-BKxx
Main Connections - mm	ø6.3	ø6.3	ø6.3	ø6.3	ø6.3	ø6.3
Maximum Pressure - Bar	8.5	8.5	8.5	8.5	8.5	8.5
Maximum Temperature						
°C - at 0 Bar	110	110	110	110	110	110
°C - at maximum pressure	50	50	50	50	50	50
Materials of Construction (2)						
Body	Nylon	PVDF	Nylon	PVDF	Nylon	PVDF
Filter Element	K Type	K Type	K Type	K Type	K Type	K Type
Principal Dimensions						
A - mm	8.3	8.3	19.5	19.5	20	20
B - mm	25.5	25.5	28	28	25.5	25.5
C - mm	45	45	80.5	80.5	84	84
Volume - cc	6	6	11	11	11	11
Filter Element Size	12-16-xx(3)	12-16-xx(3)	12-32-xx	12-32-xx	12-32-xx	12-32-xx

Notes (1) Replace 'xx' with grade required, 40, 50, 60, 70, 80, e.g. DIF-MN50, DIF-N60, DIF-K80
(2) Material abbreviation, PVDF = Polyvinylidenedifluoride
(3) Flow rates for 12-16-xx elements are half those for 12-32-xx

Intermediate & Large Disposable In-Line Filters

- Completely disposable
- Easy to install and replace
- Choice of housing materials
- Excellent chemical resistance
- Five grades of filtration
- 2 or 3 port designs



DIF-INxxC

DIF-LNxx

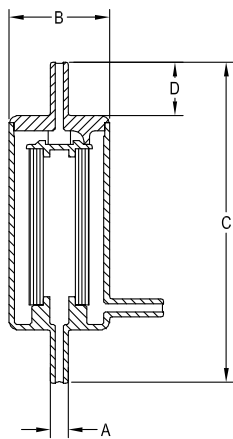

Headline Intermediate and Large Disposable In-line Filters are available in two-port or three-port configurations for particulate and coalescing applications respectively. Where running cost is more important than initial cost, plastic housings with replaceable elements should be considered - see pages 22-26.

Large DIF's are also offered with threaded ports (1/4"NPT): simply add 1/4"NPT to the product code.

Principal Specifications

Housing Model (1)	DIF-INxx	DIF-INxxC	DIF-LNxx	DIF-LNxxC	DIF-LKxx	DIF-LKxxC
Main Connections - mm	ø6.3	ø6.3	ø12.7	ø12.7	ø12.7	ø12.7
Drain Connection - mm	None	ø6.3	None	ø8.0	None	ø8.0
Maximum Pressure - Bar	7	7	7	7	7	7
Maximum Temperature						
°C - at 0 Bar	110	110	110	110	110	110
°C - at maximum pressure	50	50	50	50	50	50
Materials of Construction (2)						
Body	Nylon	Nylon	Nylon	Nylon	PVDF	PVDF
Filter Element	K Type	C Type	K Type	C Type	K Type	C Type
Principal Dimensions						
A - mm	6.35	6.35	12.7	12.7	12.7	12.7
B - mm	36.5	36.5	58	58	58	58
C - mm	117	117	139	139	139	139
D - mm	19.5	19.5	30	30	30	30
Volume - cc	50	50	120	120	120	120
Filter Element Size	12-57-xx	12-57-xxC	25-64-xx	25-64-xxC	25-64-xx	25-64-xxC

Notes (1) Replace 'xx' with grade required, 40, 50, 60, 70, 80, e.g. DIF-IN40, DIF-LN60C
 (2) Material abbreviation, PVDF = Polyvinylidenedifluoride

Disposable In-Line Adsorbers

Wide range of adsorbents
 Four body sizes available
 Disposable for convenience
 No handling of loose adsorbents

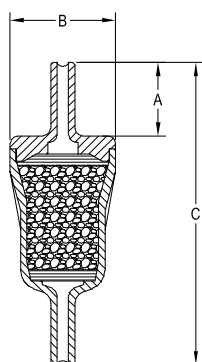

Headline Disposable In-Line Adsorbers consist of nylon bodies filled with granular adsorption material with integral inlet and outlet filter pads. Four sizes are available, containing from 6cc up to 120cc of adsorbent.

Flow rates are the same as for grade 50 elements in the same size bodies. However, with adsorption, more important considerations will be the volume of adsorbent and the contact time.

A range of adsorbent materials is available, and these are detailed below.

Principal Specifications

Housing Model (1)	DIA-MNxx	DIA-Nxx	DIA-BNxx	DIA-INxx	DIA-LNxx
Main Connections - mm	ø6.3	ø6.3	ø6.3	ø6.3	ø12.5
Maximum Pressure - Bar	8.5	8.5	8.5	7	7
Maximum Temperature					
°C - at 0 Bar	110	110	110	110	110
°C - at maximum pressure	50	50	50	50	50
Materials of Construction					
Body	Nylon	Nylon	Nylon	Nylon	Nylon
Principal Dimensions					
A - mm	8.3	19.5	20	19.5	30
B - mm	25.5	28	25.5	36.5	58
C - mm	45	80.5	84	117	139
Volume - cc	6	11	11	53	120

Note (1) Replace 'xx' with adsorbent grade required, CC, 4A, 13X, SG, MB, PP, HO e.g. DIA-MNCC, DIA-NPP, DIA-LN4A

Adsorbent	Code	Principal Uses
Activated Carbon	CC	Adsorption of hydrocarbons and other organic vapours
Molecular Sieve 4A	4A	Adsorption of CO ₂ , NH ₃ , H ₂ S, SO _x
Molecular Sieve 13X	13X	Adsorption of CO ₂ , NH ₃ , H ₂ S, SO _x , aromatics, amines
Silica Gel	SG	Adsorption of water vapour
Mixed Bases	MB	Removal of acidic gases, CO ₂ , SO _x , NO _x , HCl
Potassium permanganate	PP	Removal of SO _x and other acidic gases
Hopcalite	HO	Removal of CO by catalytic oxidation to CO ₂

Vapour Adsorption Cartridges

Wide range of adsorbents
 Cartridges to fit most housings
 Disposable for convenience
 No handling of loose adsorbents



12-32-xxTP

25-64-xx

25-178-xx

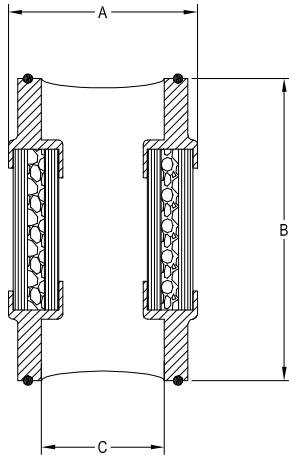

Headline vapour adsorption cartridges comprise inner and outer filter tubes with the space between filled with adsorbent. The cartridges are sealed with nylon end caps.

Headline vapour adsorption cartridges are designed to fit all standard size filter housings to provide vapour adsorption over the full range of line pressures.

Flow rates are the same as for grade 50 elements in the same size bodies. However, with adsorption, more important considerations will be the volume of adsorbent and the contact time.

Principal Specifications

Cartridge Type (1)	12-32-xx (2)	12-57-xx (3)	25-64-xx (4)	25-178-xx (4)
Maximum Temperature - °C	50	50	50	50
Principal Dimensions				
A - mm	24	24	40	40
B - mm	32	57	64	178
C - mm	12.5	12.5	26	26
Volume - cc	6	9	20	90

- Notes (1) Replace 'xx' with adsorbent grade required, CC, 4A, 13X, SG, MB, PP, HO
 (2) Add suffix 'TP' for use with 700 series plastic and 200 series aluminium housings, e.g. 12-32-CCTP, 25-64-4A
 (3) Add suffix 'TS' for use with 110 and 120 series stainless steel housings, e.g. 12-57-SGTS
 (4) Add suffix 'TP' for use with 700 series plastic and 200 series aluminium housings, e.g. 25-64-MBTP, 25-178-CCTP

Adsorbent	Code	Principal Uses
Activated Carbon	CC	Adsorption of hydrocarbons and other organic vapours
Molecular Sieve 4A	4A	Adsorption of CO ₂ , NH ₃ , H ₂ S, SO _x
Molecular Sieve 13X	13X	Adsorption of CO ₂ , NH ₃ , H ₂ S, SO _x , aromatics, amines
Silica Gel	SG	Adsorption of water vapour
Mixed Bases	MB	Removal of acidic gases, CO ₂ , SO _x , NO _x , HCl
Potassium permanganate	PP	Removal of SO _x and other acidic gases
Hopcalite	HO	Removal of CO by catalytic oxidation to CO ₂

Stainless Steel 110 & 120 Series

CE MARKED

316L stainless steel construction
 Designed to BS5500
 Choice of 2 or 3 ports
 Compact designs
 Exotic materials available



110

122

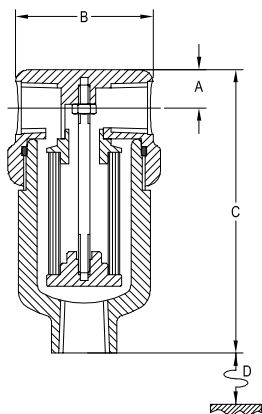

Headline 110 & 120 series filter housings are constructed entirely from 316L stainless steel with viton seals. They are free from welds and comply with NACE MR-01-75.

Specify 120 series housings for all general 1/8" and 1/4" line size applications. For applications where response time or space is critical, specify the 110 series. Where the flow rate is high or contamination is heavy, or where service intervals must be kept as long as possible, 130 and 140 series housings should be considered. For applications over 340 bar use the 110HP & 120HP series housings opposite.

These housings are also available with a PTFE seal, which requires a modified sealing design: simply add an S to the housing code, e.g. 122S. PTFE seals cannot be retrofitted into standard housings originally having viton seals. High temperature gaskets can only be fitted into S version housings.

Principal Specifications

Housing Model	110	112	114	116	120	122	124	126
Port Size - NPT	1/8"	1/4"	1/8"	1/4"	1/8"	1/4"	1/8"	1/4"
Drain - NPT	1/8"	1/4"	None	None	1/8"	1/4"	None	None
Maximum Pressure - Bar (1)	340	340	340	340	340	340	340	340
Maximum Temperature - °C (2)	200	200	200	200	200	200	200	200
Materials of Construction (3)								
Head, Bowl & Internals	316L	316L	316L	316L	316L	316L	316L	316L
Gaskets	Viton	Viton	Viton	Viton	Viton	Viton	Viton	Viton
Principal Dimensions								
A - mm	10	10	10	10	10	10	10	10
B - mm	36	36	36	36	36	36	36	36
C - mm	76	76	76	76	101	101	101	101
D - mm	40	40	40	40	65	65	65	65
Volume - cc	20	20	20	20	30	30	30	30
Weight - kg	0.3	0.3	0.3	0.3	0.4	0.4	0.4	0.4
Accessories								
Standard Gasket Set	GV110	GV110	GV110	GV110	GV110	GV110	GV110	GV110
High Temperature Gasket (for S-type housing only)	GH110	GH110	GH110	GH110	GH110	GH110	GH110	GH110
Support Core	SC110	SC110	SC110	SC110	SC120	SC120	SC120	SC120
Mounting Bracket	MB110	MB110	MB110	MB110	MB110	MB110	MB110	MB110
Filter Element Codes (4)								
Disposable Element	12-32-xx	12-32-xx	12-32-xx	12-32-xx	12-57-xx	12-57-xx	12-57-xx	12-57-xx
Stainless Steel Element	SS-110-xx	SS-110-xx	SS-110-xx	SS-110-xx	SS-120-xx	SS-120-xx	SS-120-xx	SS-120-xx
PTFE Element	PT-110-xx	PT-110-xx	PT-110-xx	PT-110-xx	PT-120-xx	PT-120-xx	PT-120-xx	PT-120-xx

- Notes (1) Above 200°C the pressure rating is reduced, consult Headline for the exact rating at any specific temperature
 (2) Maximum temperature 200°C using standard seals. For temperatures up to 500°C use a high temperature gasket
 (3) Material abbreviations, 316L = 316L Stainless steel, PTFE = Polytetrafluoroethylene
 (4) Replace 'xx' with grade required, e.g. 12-57-50C, SS-120-25, PT-120-03

Stainless Steel 110HP & 120HP Series

CE MARKED

316L stainless steel construction
 Designed to BS5500
 Choice of 2 or 3 ports
 Compact designs
 Exotic materials available



112HP



122HP

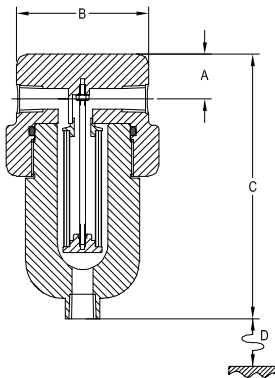

Headline 110HP & 120HP series filter housings are constructed entirely from 316L stainless steel with Viton seals. They are free from welds and comply with NACE MR-01-75.

Specify 110HP & 120HP series housings for all 1/8" and 1/4" line size applications between 340 bar and 700 bar or when the application temperature reduces the pressure rating of the standard 110 & 120 series housing below that required.

These housings are also available with a PTFE seal, which requires a modified sealing design, simply add an S to the housing code, e.g. 122HPS. PTFE seals cannot be retrofitted into standard housings originally having viton seals. High temperature gaskets can only be fitted into S version housings.

Principal Specifications

Housing Model	110HP	112HP	114HP	116HP	120HP	122HP	124HP	126HP
Port Size - NPT	1/8"	1/4"	1/8"	1/4"	1/8"	1/4"	1/8"	1/4"
Drain - NPT	1/8"	1/4"	None	None	1/8"	1/4"	None	None
Maximum Pressure - Bar (1)	700	700	700	700	700	700	700	700
Maximum Temperature - °C (2)	200	200	200	200	200	200	200	200
Materials of Construction (3)								
Head, Bowl & Internals	316L	316L	316L	316L	316L	316L	316L	316L
Gaskets	Viton	Viton	Viton	Viton	Viton	Viton	Viton	Viton
Principal Dimensions								
A - mm	22	22	22	22	22	22	22	22
B - mm	65	65	65	65	65	65	65	65
C - mm	105	105	105	105	130	130	130	130
D - mm	40	40	40	40	65	65	65	65
Volume - cc	26	26	26	26	40	40	40	40
Weight - kg	2.2	2.2	2.2	2.2	2.5	2.5	2.5	2.5
Accessories								
Standard Gasket Set	GV110HP	GV110HP	GV110HP	GV110HP	GV110HP	GV110HP	GV110HP	GV110HP
High Temperature Gasket (for S-type housings only)	GH110HP	GH110HP	GH110HP	GH110HP	GH110HP	GH110HP	GH110HP	GH110HP
Support Core	SC110	SC110	SC110	SC110	SC120	SC120	SC120	SC120
Mounting Bracket	MB130	MB130	MB130	MB130	MB130	MB130	MB130	MB130
Filter Element Codes (4)								
Disposable Element	12-32-xx	12-32-xx	12-32-xx	12-32-xx	12-57-xx	12-57-xx	12-57-xx	12-57-xx
Stainless Steel Element	SS-110-xx	SS-110-xx	SS-110-xx	SS-110-xx	SS-120-xx	SS-120-xx	SS-120-xx	SS-120-xx
PTFE Element	PT-110-xx	PT-110-xx	PT-110-xx	PT-110-xx	PT-120-xx	PT-120-xx	PT-120-xx	PT-120-xx

- Notes (1) Above 200°C the pressure rating is reduced, consult Headline for the exact rating at any specific temperature
 (2) Maximum temperature 200°C using standard seals. For temperatures up to 500°C use a high temperature gasket
 (3) Material abbreviations, 316L = 316L Stainless steel, PTFE = Polytetrafluoroethylene
 (4) Replace 'xx' with grade required, e.g. 12-32-50C, SS-120-25, PT-110-03

Stainless Steel 130 & 140 Series

316L stainless steel construction
 Designed to BS5500
 Choice of 2 or 3 ports
 100 bar pressure rating

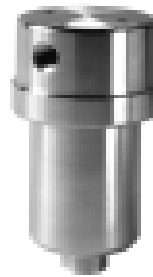
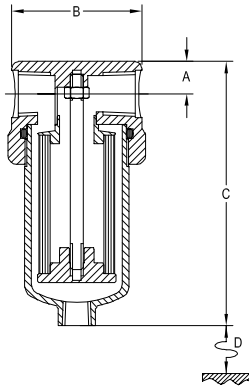

130

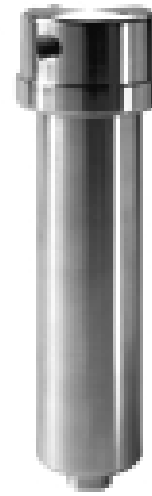

140

Headline 130 & 140 series stainless steel filters are the most frequently specified housings for applications requiring 25-64-xx or 25-178-xx sized elements. For low pressure applications the 137 and 147 housings should be considered, for pressures above 100 bar, the HP & VP ranges opposite should be used.

Principal Specifications

Housing Model	130	132	133	134	136	140	142	143	144	146
Port Size - NPT	1/4"	1/2"	1/2"	1/4"	1/2"	1/4"	1/2"	1/2"	1/4"	1/2"
Drain - NPT	1/4"	1/4"	1/2"	None	None	1/4"	1/4"	1/2"	None	None
Maximum Pressure - Bar (1)	100	100	100	100	100	100	100	100	100	100
Maximum Temperature - °C (2)	200	200	200	200	200	200	200	200	200	200
Materials of Construction (3)										
Head, Bowl & Internals	316L	316L	316L	316L	316L	316L	316L	316L	316L	316L
Gaskets	Viton	Viton	Viton	Viton	Viton	Viton	Viton	Viton	Viton	Viton
Principal Dimensions										
A - mm	15	15	15	15	15	15	15	15	15	15
B - mm	60	60	60	60	60	60	60	60	60	60
C - mm	122	122	122	122	122	236	236	236	236	236
D - mm	75	75	75	75	75	188	188	188	188	188
Volume - cc	110	110	110	110	110	265	265	265	265	265
Weight - kg	0.7	0.7	0.7	0.7	0.7	1.1	1.1	1.1	1.1	1.1
Accessories										
Standard Gasket Set	GV130	GV130	GV130	GV130	GV130	GV130	GV130	GV130	GV130	GV130
High Temperature Gasket (for S-type housings only)	GH130	GH130	GH130	GH130	GH130	GH130	GH130	GH130	GH130	GH130
Support Core	SC130	SC130	SC130	SC130	SC130	SC140	SC140	SC140	SC140	SC140
Mounting Bracket	MB130	MB130	MB130	MB130	MB130	MB130	MB130	MB130	MB130	MB130
Filter Element Codes (4)										
Disposable Element	25-64-xx	25-64-xx	25-64-xx	25-64-xx	25-64-xx	25-178-xx	25-178-xx	25-178-xx	25-178-xx	25-178-xx
Stainless Steel Element	SS-130-xx	SS-130-xx	SS-130-xx	SS-130-xx	SS-130-xx	SS-140-xx	SS-140-xx	SS-140-xx	SS-140-xx	SS-140-xx
PTFE Element	PT-130-xx	PT-130-xx	PT-130-xx	PT-130-xx	PT-130-xx	PT-140-xx	PT-140-xx	PT-140-xx	PT-140-xx	PT-140-xx

Notes (1) Above 200°C the pressure rating is reduced, consult Headline for the exact rating at any specific temperature
 (2) Maximum temperature 200°C using standard seals. For temperatures up to 500°C use a high temperature gasket
 (3) Material abbreviations, 316L = 316L Stainless steel, PTFE = Polytetrafluoroethylene
 (4) Replace 'xx' with grade required, e.g. 25-64-50C, SS-130-25, PT-130-03

Stainless Steel 130/140 HP & VP Series CE MARKED

316L stainless steel construction
 Designed to BS5500
 Choice of 2 or 3 ports
 HP series to 200 bar
 VP series to 400 bar

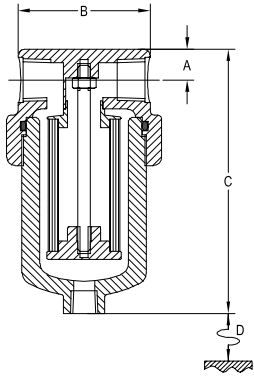

Headline high pressure 130HP & 140HP series housings are specified for pressures above 100 bar, where 25-64-xx and 25-178-xx sized elements are required. For pressures between 200 and 400 bar 130VP and 140VP series housings should be specified.

Principal Specifications (Figures in brackets are for VP versions)

Housing Model	130HP	132HP	134HP	136HP	140HP	142HP	144HP	146HP
Port Size - NPT	1/4"	1/2"	1/4"	1/2"	1/4"	1/2"	1/4"	1/2"
Drain - NPT	1/4"	1/4"	None	None	1/4"	1/4"	None	None
Maximum Pressure - Bar (1)	200 (400)	200 (400)	200 (400)	200 (400)	200 (400)	200 (400)	200 (400)	200 (400)
Maximum Temperature - °C (2)	200	200	200	200	200	200	200	200
Materials of Construction (3)								
Head, Bowl & Internals	316L	316L	316L	316L	316L	316L	316L	316L
Gaskets	Viton	Viton	Viton	Viton	Viton	Viton	Viton	Viton
Principal Dimensions								
A - mm	15 (21)	15 (21)	15 (21)	15 (21)	15 (21)	15 (21)	15 (21)	15 (21)
B - mm	64 (85)	64 (85)	64 (85)	64 (85)	64 (85)	64 (85)	64 (85)	64 (85)
C - mm	129 (164)	129 (164)	129 (164)	129 (164)	243 (276)	243 (276)	243 (276)	243 (276)
D - mm	70 (75)	70 (75)	70 (75)	70 (75)	184 (190)	184 (190)	184 (190)	243 (276)
Volume - cc	115(160)	115(160)	115(160)	115(160)	300(320)	300(320)	300(320)	300(320)
Weight - kg	2.1(4.5)	2.1(4.5)	2.1(4.5)	2.1(4.5)	3.2(6.5)	3.2(6.5)	3.2(6.5)	3.2(6.5)
Accessories								
Standard Gasket Set	GV130HP (GV130VP)	GV130HP (GV130VP)	GV130HP (GV130VP)	GV130HP (GV130VP)	GV130HP (GV130VP)	GV130HP (GV130VP)	GV130HP (GV130VP)	GV130HP (GV130VP)
High Temperature Gasket (for S-type housings only)	GH130HP (GH130VP)	GH130HP (GH130VP)	GH130HP (GH130VP)	GH130HP (GH130VP)	GH130HP (GH130VP)	GH130HP (GH130VP)	GH130HP (GH130VP)	GH130HP (GH130VP)
Support Core	SC130	SC130	SC130	SC130	SC140	SC140	SC140	SC140
Mounting Bracket	MB130 (MB150)	MB130 (MB150)	MB130 (MB150)	MB130 (MB150)	MB130 (MB150)	MB130 (MB150)	MB130 (MB150)	MB130 (MB150)
Filter Element Codes (4)								
Disposable Element	25-64-xx	25-64-xx	25-64-xx	25-64-xx	25-178-xx	25-178-xx	25-178-xx	25-178-xx
Stainless Steel Element	SS-130-xx	SS-130-xx	SS-130-xx	SS-130-xx	SS-140-xx	SS-140-xx	SS-140-xx	SS-140-xx
PTFE Element	PT-130-xx	PT-130-xx	PT-130-xx	PT-130-xx	PT-140-xx	PT-140-xx	PT-140-xx	PT-140-xx

Notes (1) Above 200°C the pressure rating is reduced, consult Headline for the exact rating at any specific temperature
 (2) Maximum temperature 200°C using standard seals. For temperatures up to 500°C use a high temperature gasket
 (3) Material abbreviations, 316L = 316L Stainless steel, PTFE = Polytetrafluoroethylene
 (4) Replace 'xx' with grade required, e.g. 25-64-50C, SS-130-25, PT-140-03

Stainless Steel Low Pressure Housings

316L stainless steel construction
 Designed to BS5500
 Low cost design for
 low pressure applications

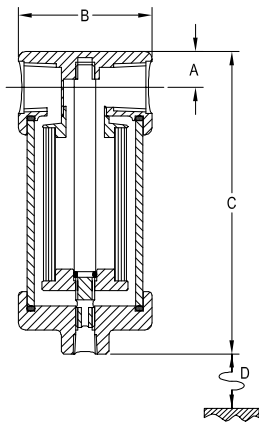

This range of stainless steel housings is constructed entirely from 316L stainless steel to a low cost design. They are used extensively in gas analysis applications requiring all stainless steel construction.

Principal Specifications

Housing Model	117	127	137	138	147	148
Port Size - NPT	1/4"	1/4"	1/4"	1/2"	1/4"	1/2"
Drain - NPT	1/8"	1/8"	1/4"	1/4"	1/4"	1/4"
Maximum Pressure - Bar	7	7	7	7	7	7
Maximum Temperature - °C	100	100	100	100	100	100
Materials of Construction (1)						
Head, Base & Internals	316L	316L	316L	316L	316L	316L
Bowl	316L	316L	316L	316L	316L	316L
Gaskets	Viton	Viton	Viton	Viton	Viton	Viton
Principal Dimensions						
A - mm	12	12	15	15	15	15
B - mm	40	40	56	56	56	56
C - mm	83	109	131	131	245	245
D - mm	18	42	70	70	184	184
Volume - cc	29	39	110	110	250	250
Weight - kg	0.3	0.4	1.0	1.0	1.2	1.2
Accessories						
Gasket Set	GV127	GV127	GV137	GV137	GV137	GV137
Support Core	SC110	SC120	SC130	SC130	SC140	SC140
Mounting Bracket	MB110	MB110	MB130	MB130	MB130	MB130
Filter Element Codes (2)						
Disposable Element	12-32-xx	12-57-xx	25-64-xx	25-64-xx	25-178-xx	25-178-xx
Stainless Steel Element	SS-110-xx	SS-120-xx	SS-130-xx	SS-130-xx	SS-140-xx	SS-140-xx
PFTE Element	PT-110-xx	PT-120-xx	PT-130-xx	PT-130-xx	PT-140-xx	PT-140-xx

Notes (1) Material abbreviation, 316L = 316L Stainless steel
 (2) Replace 'xx' with grade required, e.g. 12-57-50C, PT-120-03, SS-140-10

Stainless Steel Housing with Glass Bowls

316L stainless steel construction
 Designed to BS5500
 Pyrex glass bowl
 Excellent chemical resistance

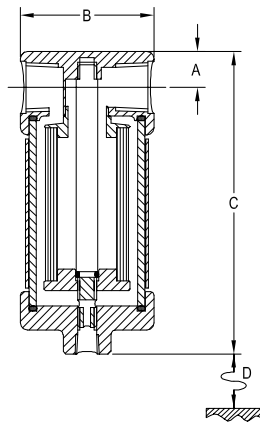

The Headline range of low pressure stainless steel housings is extended by the use of pyrex glass bowls. This allows the condition of the filter element to be monitored visually. This is important in systems subject to slugs of water, especially those under negative pressure requiring manual draining. Guards are fitted as standard to all pyrex bowls.

Principal Specifications

Housing Model	117G	127G	137G	138G	147G	148G
Port Size - NPT	1/4"	1/4"	1/4"	1/2"	1/4"	1/2"
Drain - NPT	1/8"	1/8"	1/4"	1/4"	1/4"	1/4"
Maximum Pressure - Bar	7	7	7	7	7	7
Maximum Temperature - °C	100	100	100	100	100	100
Materials of Construction (1)						
Head, Base & Internals	316L	316L	316L	316L	316L	316L
Bowl	Pyrex	Pyrex	Pyrex	Pyrex	Pyrex	Pyrex
Gaskets	Viton	Viton	Viton	Viton	Viton	Viton
Principal Dimensions						
A - mm	12	12	15	15	15	15
B - mm	40	40	56	56	56	56
C - mm	83	109	131	131	245	245
D - mm	18	42	70	70	184	184
Volume - cc	29	39	110	110	250	250
Weight - kg	0.3	0.4	1.0	1.0	1.2	1.2
Accessories						
Gasket Set	GV127	GV127	GV137	GV137	GV137	GV137
Support Core	SC110	SC120	SC130	SC130	SC140	SC140
Mounting Bracket	MB110	MB110	MB130	MB130	MB130	MB130
Filter Element Codes (2)						
Disposable Element	12-32-xx	12-57-xx	25-64-xx	25-64-xx	25-178-xx	25-178-xx
Stainless Steel Element	SS-110-xx	SS-120-xx	SS-130-xx	SS-130-xx	SS-140-xx	SS-140-xx
PFTE Element	PT-110-xx	PT-120-xx	PT-130-xx	PT-130-xx	PT-140-xx	PT-140-xx

Notes (1) Material abbreviations, 316L = 316L Stainless steel, Pyrex = Borosilicate glass
 (2) Replace 'xx' with grade required, e.g. 12-57-50C, PT-120-03, SS-140-10

Stainless Steel In-Line Series

316L stainless steel construction
 Designed to BS5500
 Compact design
 Ideal last-chance filter

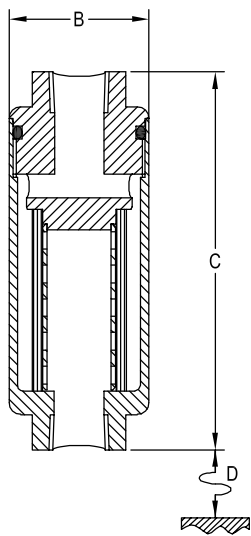

Headline Stainless Steel In-line Filters are used where the convenience of element change is not an important consideration. For example, in very lightly contaminated gases where service intervals are very long or for last-chance or back-up filters where the filter is only expected to be used in the event of a system failure.

Principal Specifications

Housing Model	116IL	126IL	136IL	146IL
Port Size - NPT	1/4"	1/4"	1/2"	1/2"
Maximum Pressure - Bar (1)	340	340	100	100
Maximum Temperature - °C	200	200	200	200
Materials of Construction (2)				
Head, Bowl & Internals	316L	316L	316L	316L
Gaskets	Viton	Viton	Viton	Viton
Principal Dimensions				
B - mm	35	35	48	48
C - mm	79	104	129	243
D - mm	50	75	95	210
Volume - cc	18	28	100	260
Weight - kg	0.36	0.44	0.85	1.2
Accessories				
Standard Gasket Set	GV116IL	GV116IL	GV136IL	GV136IL
Filter Element Codes (3)				
Disposable Element	12-32-xx	12-57-xx	25-64-xx	25-178-xx
Stainless Steel Element	SS-110-xx	SS-120-xx	SS-130-xx	SS-140-xx
PTFE Element	PT-110-xx	PT-120-xx	PT-130-xx	PT-140-xx

Notes (1) Above 200°C the pressure rating is reduced, consult Headline for the exact rating at any specific temperature
 (2) Material abbreviation, 316L = 316L Stainless steel
 (3) Replace 'xx' with grade required, e.g. 25-64-50C, SS-130-25, PT-130-03

Stainless Steel Fast Loop Series

316L stainless steel construction
Designed to BS5500
Minimise reponse time

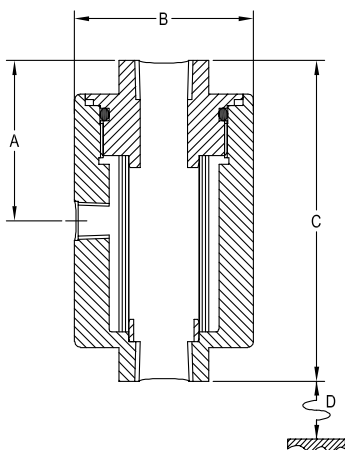

Headline Fast Loop Filters are specified where response time is critical. The filter is sited as closely as possible to the Gas Analyser, and the process gas is pumped through the filter housing at high velocity. The sample for analysis is drawn through the filter element to the Analyser, with the bulk of the process gas returned to the process unfiltered.

Principal Specifications

Housing Model	116IL-3	126IL-3	136IL-3	146IL-3
Port Size - NPT	1/4"	1/4"	1/2"	1/2"
Sample Port Size - NPT	1/4"	1/4"	1/4"	1/4"
Maximum Pressure - Bar (1)	340	340	100	100
Maximum Temperature - °C	200	200	200	200
Materials of Construction (2)				
Head, Bowl & Internals	316L	316L	316L	316L
Gaskets	Viton	Viton	Viton	Viton
Principal Dimensions				
A - mm	35.5	48	57	114
B - mm	50	50	63.5	63.5
C - mm	71	96	114	232
D - mm	50	75	85	200
Volume - cc	20	28	94	240
Weight - kg	0.7	1.0	1.6	3.3
Accessories				
Standard Gasket Set	GV126IL-3	GV126IL-3	GV136IL-3	GV136IL-3
Filter Element Codes (3)				
Disposable Element	12-32-xx	12-57-xx	25-64-xx	25-178-xx
Stainless Steel Element	SS-110-xx	SS-120-xx	SS-130-xx	SS-140-xx
PTFE Element	PT-110-xx	PT-120-xx	PT-130-xx	PT-140-xx

Notes (1) Above 200°C the pressure rating is reduced, consult Headline for the exact rating at any specific temperature
(2) Material abbreviation, 316L = 316L Stainless steel
(3) Replace 'xx' with grade required, e.g. 25-64-50C, SS-130-25, PT-140-03

Drain Vessels & Float Drains

FD130 Float Drain automatically removes liquids from the filter

Drain Vessels are used to manually drain liquids from filters under negative pressure

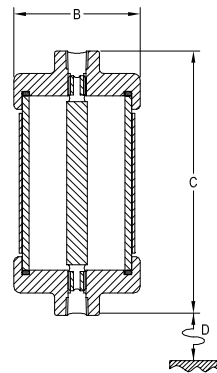
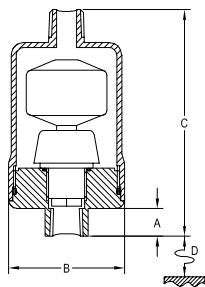

FD130

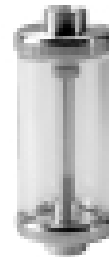

DV127G

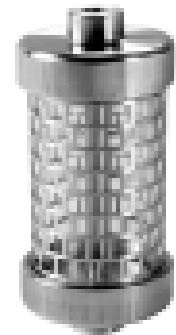

DV137G

The FD130 automatic float drain is used in positive pressure systems to remove large quantities of liquid. The drain is added to the drain port of a filter housing fitted with a coalescing filter element. The liquid drains from the housing into the automatic float drain and collects in the bottom. As the level of the liquid rises, the float will open a valve, and the liquid drains out. The FD130 automatic float drain is suitable for use in systems with a positive pressure between 1 bar and 15 bar.

For applications under a negative pressure, drain vessels can be used to collect large quantities of liquid. Valves installed at each end of the drain vessel will allow liquid to be isolated from the system and drained.

Principal Specifications

Housing Model	DV127G	DV137G	DV147G	FD130
Port Size - NPT	1/8"	1/4"	1/4"	1/4"
Maximum Pressure - Bar	7	7	7	15
Maximum Temperature - °C	100	100	100	100
Materials of Construction (1)				
Head, Base & Internals	316L	316L	316L	316L
Bowl	Pyrex	Pyrex	Pyrex	316L
Gaskets	Viton	Viton	Viton	Viton
Principal Dimensions				
A - mm	-	-	-	10
B - mm	40	56	56	46
C - mm	97	118	232	90
D - mm	70	90	204	50
Volume - cc	36	105	255	30
Weight - kg	0.2	0.6	0.8	0.34
Accessories				
Gasket Set	GV127	GV137	GV137	GVFD130

Notes (1) Material abbreviations, 316L = 316L Stainless steel, Pyrex = Borosilicate glass

Stainless Steel Heatable Housing

316L stainless steel construction

Designed to BS5500

Change element in seconds
even at 200°C

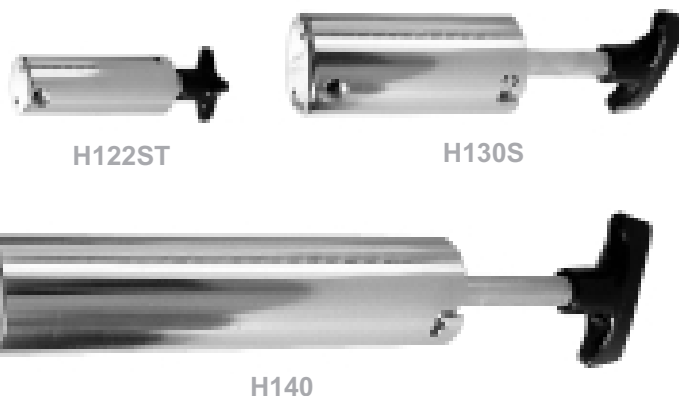
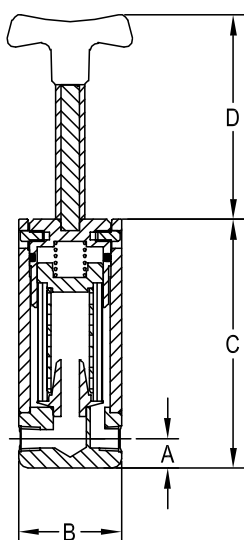

Headline heatable housings are purpose designed for hot gas analysis, such as diesel exhaust at 200°C. The housings can be heated by any external heater, and the bayonet type head to bowl connection allows the filter element to be changed in seconds, even at operating temperature. All housings have integral support cores for positive element location and spring loaded element retainers for reliable sealing over the full temperature range.

Models H130 & H140 have inlet and outlet ports in the base allowing the entire OD of the housing to be heated. Housings with S or ST suffix have both ports in the side of the housing as in the drawing. Housings with T in the suffix have the elements sealed by conventional tie-rod and element retainer.

Principal Specifications

Housing Model	H122ST	H130	H130S	H130T	H130ST	H140	H140S	H140T	H140ST
Port Size - NPT	1/4"	1/4"	1/4"	1/4"	1/4"	1/4"	1/4"	1/4"	1/4"
Maximum Pressure - Bar	2	2	2	2	2	2	2	2	2
Maximum Temperature - °C	200	200	200	200	200	200	200	200	200
Materials of Construction (1)									
Head, Bowl & Internals	316L	316L	316L	316L	316L	316L	316L	316L	316L
Gaskets	Silicone	Silicone	Silicone	Silicone	Silicone	Silicone	Silicone	Silicone	Silicone
Principal Dimensions									
A - mm	10	-	16	-	16	-	16	-	16
B - mm	38	52.5	56	52.5	56	52.5	56	52.5	56
C - mm	120	116	135	120	135	230	249	234	249
D - mm	42	120	120	120	120	120	120	120	120
Volume - cc	55	100	100	100	100	240	240	240	240
Weight - kg	0.65	1.2	1.7	1.5	1.7	1.9	2.9	2.5	2.9
Accessories									
Standard Gasket Set	GSH120	GSH130	GSH130	GSH130	GSH130	GSH130	GSH130	GSH130	GSH130
Viton Gasket Set	GVH120	GVH130	GVH130	GVH130	GVH130	GVH130	GVH130	GVH130	GVH130
Filter Element Codes (2)									
Disposable Element (3)	12-57-xxS	25-64-xxS	25-64-xxS	25-64-xxS	25-64-xxS	25-178-xxS	25-178-xxS	25-178-xxS	25-178-xxS
Stainless Steel Element	SS-120-xx	SS-130-xx	SS-130-xx	SS-130-xx	SS-130-xx	SS-140-xx	SS-140-xx	SS-140-xx	SS-140-xx
PTFE Element	PT-120-xx	PT-130-xx	PT-130-xx	PT-130-xx	PT-130-xx	PT-140-xx	PT-140-xx	PT-140-xx	PT-140-xx

Notes

(1) Material abbreviation, 316L = 316L Stainless steel

(2) Replace 'xx' with grade required, e.g. 25-64-50C, SS-130-25, PT-140-03

(3) S-type elements only recommended for heatable housings

PTFE Housings

Virgin PTFE construction
 Viton seals
 7 bar pressure rating
 Excellent chemical resistance

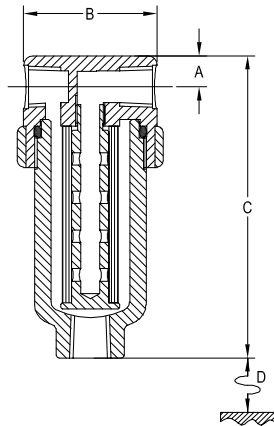

Headline PTFE housings are designed specifically for use in high chemical resistance or very low adsorption applications. They are used with Kynar bonded disposable elements for particulate removal or coalescing applications. Where only PTFE is allowable, sintered PTFE elements should be specified.

Principal Specifications

Housing Model	120P	122P	130P	132P	140P	142P
Port Size - NPT	1/8"	1/4"	1/4"	1/2"	1/4"	1/2"
Drain - NPT	1/8"	1/4"	1/4"	1/4"	1/4"	1/4"
Maximum Pressure - Bar	7	7	7	7	7	7
Maximum Temperature - °C	150	150	150	150	150	150
Materials of Construction (1)						
Head & Internals	PTFE	PTFE	PTFE	PTFE	PTFE	PTFE
Bowl	PTFE	PTFE	PTFE	PTFE	PTFE	PTFE
Gaskets	Viton	Viton	Viton	Viton	Viton	Viton
Principal Dimensions						
A - mm	10	10	15	15	15	15
B - mm	43	43	63	63	63	63
C - mm	98	98	122	122	236	236
D - mm	62	62	70	70	184	184
Volume - cc	33	33	90	90	260	260
Weight - kg	0.2	0.2	0.55	0.55	0.75	0.75
Accessories						
Gasket Set	GV120P	GV120P	GV130P	GV130P	GV130P	GV130P
Mounting Bracket	MB110	MB110	MB130	MB130	MB130	MB130
Filter Element Codes (2)						
Disposable Element	12-57-xx	12-57-xx	25-64-xx	25-64-xx	25-178-xx	25-178-xx
PFTE Element	PT-120-xx	PT-120-xx	PT-130-xx	PT-130-xx	PT-140-xx	PT-140-xx

Notes (1) Material abbreviation, PTFE = Polytetrafluoroethene
 (2) Replace 'xx' with grade required, e.g. 25-64-50C, PT-130-03

PTFE Housings with Glass Bowls

Virgin PTFE construction
 Pyrex glass bowls
 7 bar pressure rating
 Element can be monitored visually

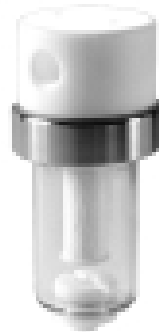
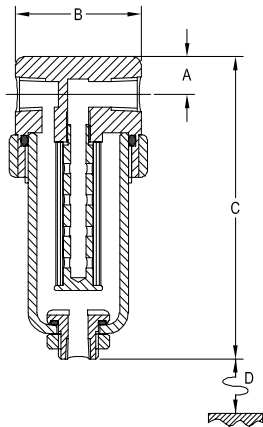

122PG



130PG

The Headline range of PTFE housings is extended by the availability of these versions with pyrex glass bowls. The condition of the filter element can be monitored visually which is important in systems where slugs of condensate may occur.

Principal Specifications

Housing Model	120PG	122PG	130PG	132PG
Port Size - NPT	1/8"	1/4"	1/4"	1/2"
Drain - NPT	1/8"	1/8"	1/8"	1/8"
Maximum Pressure - Bar	7	7	7	7
Max. Temperature °C	100	100	100	100
Materials of Construction (1)				
Head & Internals	PTFE	PTFE	PTFE	PTFE
Bowl	Pyrex	Pyrex	Pyrex	Pyrex
Gaskets	Viton	Viton	Viton	Viton
Principal Dimensions				
A - mm	15	15	15	15
B - mm	50	50	68	68
C - mm	110	110	135	135
D - mm	62	62	70	70
Volume - cc	63	63	155	155
Weight - kg	0.3	0.3	0.6	0.6
Accessories				
Gasket Set	GV120PG	GV120PG	GV130PG	GV130PG
Mounting Bracket	MB110	MB110	MB130	MB130
Filter Element Codes (2)				
Disposable Element	12-57-xx	12-57-xx	25-64-xx	25-64-xx
PTFE Element	PT-120-xx	PT-120-xx	PT-130-xx	PT-130-xx

Notes (1) Material abbreviations, PTFE = Polytetrafluoroethene, Pyrex = Borosilicate glass
 (2) Replace 'xx' with grade required, e.g. 12-57-50C, PT-130-03

Nylon Housings

All nylon housings
Nylon / PC also available
Low Cost
Ideal for portable analysers

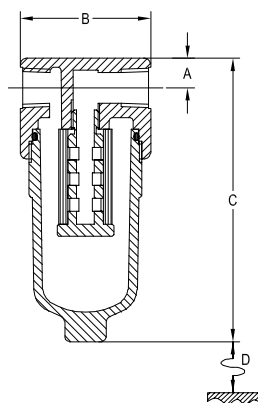

Headline nylon housings are available in two versions: all nylon with transparent nylon bowl, or with lower cost polycarbonate bowl. Housings for element sizes 12-32 to 25-178 are available, either with a manual drain valve or with no drain. These housings are widely used in low pressure systems where plastics can be specified.

Principal Specifications

Housing Model	700N	705N	700NC	705NC	720N	725N	720NC	725NC
Port Size - NPT	1/8"	1/4"	1/8"	1/4"	1/8"	1/4"	1/8"	1/4"
Drain	None	None	None	None	None	None	None	None
For Manual Drain order Model	701N	710N	701NC	710NC	721N	730N	721NC	730NC
Maximum Pressure - Bar	7	7	7	7	7	7	7	7
Maximum Temperature - °C	50	50	50	50	50	50	50	50
Materials of Construction (1)								
Head & Internals	Nylon	Nylon	Nylon	Nylon	Nylon	Nylon	Nylon	Nylon
Bowl	Nylon	Nylon	PC	PC	Nylon	Nylon	PC	PC
Gaskets	Viton	Viton	Viton	Viton	Viton	Viton	Viton	Viton
Principal Dimensions								
A - mm	10	10	10	10	10	10	10	10
B - mm	44	44	44	44	44	44	44	44
C - mm (2)	96 (106)	96 (106)	96 (106)	96 (106)	112 (122)	112 (122)	112 (122)	112 (122)
D - mm	38	38	38	38	60	60	60	60
Volume - cc	50	50	50	50	60	60	60	60
Weight - kg	0.06	0.06	0.06	0.06	0.06	0.06	0.06	0.06
Accessories								
Standard Gasket Set	GV710	GV710	GV710	GV710	GV710	GV710	GV710	GV710
Mounting Bracket	MB110	MB110	MB110	MB110	MB110	MB110	MB110	MB110
Filter Element Codes (3)								
Disposable Element	12-32-xx	12-32-xx	12-32-xx	12-32-xx	12-57-xx	12-57-xx	12-57-xx	12-57-xx
PTFE Element	PT-110-xx	PT-110-xx	PT-110-xx	PT-110-xx	PT-120-xx	PT-120-xx	PT-120-xx	PT-120-xx

Notes (1) Material abbreviation, PC = Polycarbonate
(2) Dimension in brackets is for the manual drain version of the housing
(3) Replace 'xx' with grade required, e.g. 12-32-50C, PT-120-03

Nylon Housings

All nylon housings
Nylon / PC also available
Low cost
Ideal for automotive use

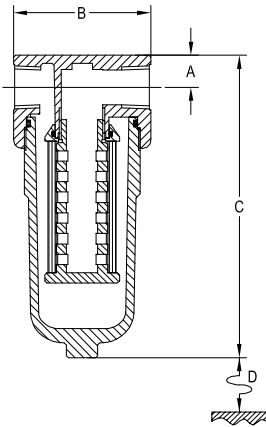

Depending on the chemical nature of the gas being filtered, other plastic filter housings should be considered e.g. polypropylene, (pages 24-25) or PVDF (page 26). The convenience of complete disposability and low initial cost may make Headline's DIF's (page 6-7) a more suitable product option. Housings accepting elements 12-32 & 12-57 are sold singly or in packs of 100. Housings accepting elements 25-64 & 25-178 are sold singly or in packs of 25.

Principal Specifications

Housing Model	750N	755N	750NC	755NC	772N	775N	772NC	775NC
Port Size - NPT	1/4"	1/2"	1/4"	1/2"	1/4"	1/2"	1/4"	1/2"
Drain	None	None	None	None	None	None	None	None
For Manual Drain order Model	751N	760N	751NC	760NC	771N	780N	771NC	780NC
Maximum Pressure - Bar	7	7	7	7	7	7	7	7
Maximum Temperature - °C	50	50	50	50	50	50	50	50
Materials of Construction (1)								
Head & Internals	Nylon	Nylon	Nylon	Nylon	Nylon	Nylon	Nylon	Nylon
Bowl	Nylon	Nylon	PC	PC	Nylon	Nylon	PC	PC
Gaskets	Viton	Viton	Viton	Viton	Viton	Viton	Viton	Viton
Principal Dimensions								
A - mm	15.5	15.5	15.5	15.5	15.5	15.5	15.5	15.5
B - mm	66	66	66	66	66	66	66	66
C - mm (2)	146 (156)	146 (156)	146 (156)	146 (156)	248 (258)	248 (258)	248 (258)	248 (258)
D - mm	80	80	80	80	195	195	195	195
Volume - cc	170	170	170	170	310	310	310	310
Weight - kg	0.2	0.2	0.2	0.2	0.25	0.25	0.25	0.25
Accessories								
Standard Gasket Set	GV760	GV760	GV760	GV760	GV760	GV760	GV760	GV760
Mounting Bracket	MB130	MB130	MB130	MB130	MB130	MB130	MB130	MB130
Filter Element Codes (3)								
Disposable Element	25-64-xx	25-64-xx	25-64-xx	25-64-xx	25-178-xx	25-178-xx	25-178-xx	25-178-xx
PTFE Element	PT-130-xx	PT-130-xx	PT-130-xx	PT-130-xx	PT-140-xx	PT-140-xx	PT-140-xx	PT-140-xx

Notes (1) Material abbreviation, PC = Polycarbonate
(2) Dimension in brackets is for the manual drain version
(3) Replace 'xx' with grade required, e.g. 25-64-50C, PT-140-03

Polypropylene Housings

All polypropylene construction
 Polycarbonate bowl available
 Low cost
 Ideal for portable analysers
 Good chemical resistance

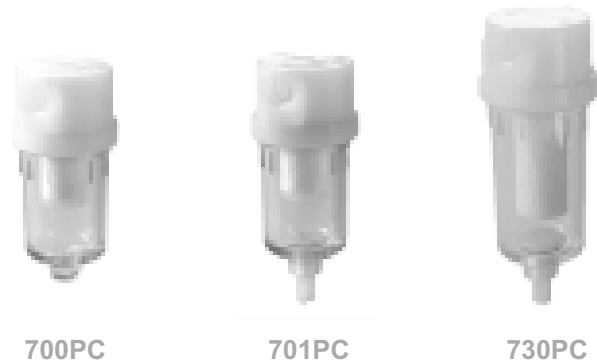
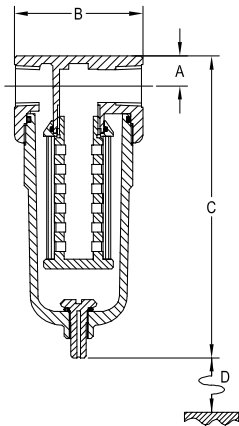

Headline's range of polypropylene housings are available with a choice of polypropylene or low cost transparent polycarbonate bowl. Each housing configuration is available without a drain for particulate filtration, or with a manual drain for coalescing applications. These housings are widely used in low pressure systems requiring low cost filters, with the good chemical resistance polypropylene provides.

Principal Specifications

Housing Model	700P	705P	700PC	705PC	720P	725P	720PC	725PC
Port Size - NPT	1/8"	1/4"	1/8"	1/4"	1/8"	1/4"	1/8"	1/4"
Drain	None	None	None	None	None	None	None	None
For Manual Drain order Model	701P	710P	701PC	710PC	721P	730P	721PC	730PC
Maximum Pressure - Bar	7	7	7	7	7	7	7	7
Maximum Temperature - °C	50	50	50	50	50	50	50	50
Materials of Construction (1)								
Head & Internals	PP	PP	PP	PP	PP	PP	PP	PP
Bowl	PP	PP	PC	PC	PP	PP	PC	PC
Gaskets	Viton	Viton	Viton	Viton	Viton	Viton	Viton	Viton
Principal Dimensions								
A - mm	10	10	10	10	10	10	10	10
B - mm	44	44	44	44	44	44	44	44
C - mm	96 (106)	96 (106)	96 (106)	96 (106)	112 (122)	112 (122)	112 (122)	112 (122)
D - mm	38	38	38	38	60	60	60	60
Volume - cc	50	50	50	50	60	60	60	60
Weight - kg	0.06	0.06	0.06	0.06	0.06	0.06	0.06	0.06
Accessories								
Standard Gasket Set	GV710	GV710	GV710	GV710	GV710	GV710	GV710	GV710
Mounting Bracket	MB110	MB110	MB110	MB110	MB110	MB110	MB110	MB110
Filter Element Codes (2)								
Disposable Element	12-32-xx	12-32-xx	12-32-xx	12-32-xx	12-57-xx	12-57-xx	12-57-xx	12-57-xx
PTFE Element	PT-110-xx	PT-110-xx	PT-110-xx	PT-110-xx	PT-120-xx	PT-120-xx	PT-120-xx	PT-120-xx

Notes (1) Material abbreviations, PC = Polycarbonate, PP = Polypropylene
 (2) Replace 'xx' with grade required, e.g. 12-32-50C, PT-120-03

Polypropylene Housings

All polypropylene construction
 Polycarbonate bowls available
 Low cost
 Ideal for portable analysers
 Good chemical resistance

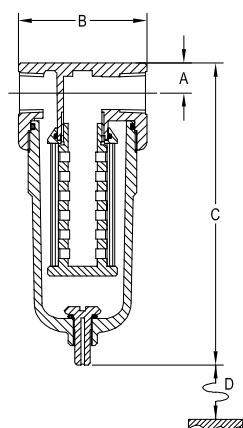

All polypropylene housings will provide a low cost alternative to PTFE & PVDF housings for many applications where the chemical resistance of polypropylene is sufficient. Housings with transparent polycarbonate bowls are available to allow visual monitoring of the element condition. Housings accepting elements 12-32 and 12-57 are sold singly or in packs of 100, while housings accepting elements 25-64 & 25-178 are sold singly or in packs of 25.

Principal Specifications

Housing Model	750P	755P	750PC	755PC	772P	775P	772P	775PC
Port Size - NPT	1/4"	1/2"	1/4"	1/2"	1/4"	1/2"	1/4"	1/2"
Drain	None	None	None	None	None	None	None	None
For Manual Drain order Model	751P	760P	751PC	760PC	771P	780P	771PC	780PC
Maximum Pressure - Bar	7	7	7	7	7	7	7	7
Maximum Temperature - °C	50	50	50	50	50	50	50	50
Materials of Construction (1)								
Head & Internals	PP	PP	PP	PP	PP	PP	PP	PP
Bowl	PP	PP	PC	PC	PP	PP	PC	PC
Gaskets	Viton	Viton	Viton	Viton	Viton	Viton	Viton	Viton
Principal Dimensions								
A - mm	15.5	15.5	15.5	15.5	15.5	15.5	15.5	15.5
B - mm	66	66	66	66	66	66	66	66
C - mm	146 (156)	146 (156)	146 (156)	146 (156)	248 (258)	248 (258)	248 (258)	248 (258)
D - mm	80	80	80	80	195	195	195	195
Volume - cc	172	172	172	172	312	312	312	312
Weight - kg	0.2	0.2	0.2	0.2	0.25	0.25	0.25	0.25
Accessories								
Standard Gasket Set	GV760	GV760	GV760	GV760	GV760	GV760	GV760	GV760
Mounting Bracket	MB130	MB130	MB130	MB130	MB130	MB130	MB130	MB130
Filter Element Codes (2)								
Disposable Element	25-64-xx	25-64-xx	25-64-xx	25-64-xx	25-178-xx	25-178-xx	25-178-xx	25-178-xx
PTFE Element	PT-130-xx	PT-130-xx	PT-130-xx	PT-130-xx	PT-140-xx	PT-140-xx	PT-140-xx	PT-140-xx

Notes (1) Material abbreviations, PC = Polycarbonate, PP = Polypropylene
 (2) Replace 'xx' with grade required, e.g. 25-64-50C, PT-140-03

PVDF Housings

All PVDF (Kynar) construction
 Viton Seals
 Excellent chemical resistance

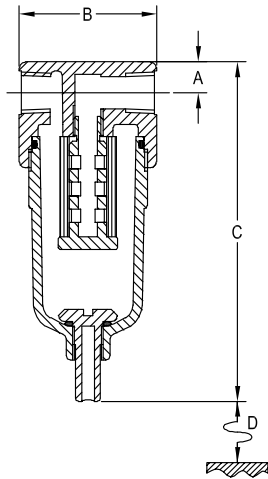

PVDF housings are specified in applications where chemical resistance is of prime importance. To preserve the exceptional chemical resistance of the housing, only PVDF bonded disposable elements (K-type for particulate removal, C-type for coalescing) or PTFE elements should be used.

Principal Specifications

Housing Model	700K	705K	720K	725K	750K	755K
Port Size - NPT	1/8"	1/4"	1/8"	1/4"	1/4"	1/2"
Drain - NPT or Manual	None	None	None	None	None	None
For Manual Drain order Model	701K	710K	721K	730K	751K	760K
Maximum Pressure - Bar	7	7	7	7	7	7
Maximum Temperature - °C	120	120	120	120	120	120
Materials of Construction (1)						
Head & Internals	PVDF	PVDF	PVDF	PVDF	PVDF	PVDF
Bowl	PVDF	PVDF	PVDF	PVDF	PVDF	PVDF
Gaskets	Viton	Viton	Viton	Viton	Viton	Viton
Principal Dimensions						
A - mm	10	10	10	10	15.5	15.5
B - mm	44	44	44	44	66	66
C - mm	96 (106)	96 (106)	112 (122)	112 (122)	146 (156)	146 (156)
D - mm	38	38	60	60	80	80
Volume - cc	50	50	60	60	172	172
Weight - kg	0.06	0.06	0.06	0.06	0.2	0.2
Accessories						
Gasket Set	GV710	GV710	GV710	GV710	GV760	GV760
Mounting Bracket	MB110	MB110	MB110	MB110	MB130	MB130
Filter Element Codes (2)						
Disposable Element (3)	12-32-xx	12-32-xx	12-57-xx	12-57-xx	25-64-xx	25-64-xx
PTFE Element	PT-110-xx	PT-110-xx	PT-120-xx	PT-120-xx	PT-130-xx	PT-130-xx

Notes (1) Material abbreviation, PVDF = Polyvinylidenedifluoride
 (2) Replace 'xx' with grade required, e.g. 12-32-50C, PT-110-03
 (3) Use K-type or C-type disposable elements only

Nylon 770 Series Housings

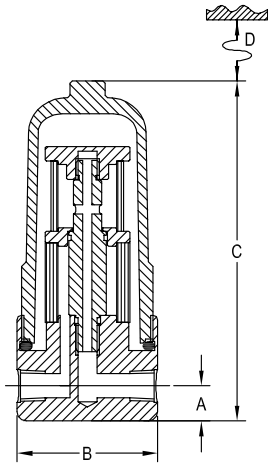

707N

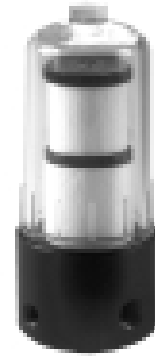

770

Headline 770 series is specifically designed for petrol engine analysis and, uniquely, has a coalescing pre-filter and particulate final filter in one housing. The housings are designed so that the inlet, outlet and drain connections are permanent and the element change is very simple. The two filter elements have different lengths and cannot be installed incorrectly. 770 series housings replace the usual two housing installation, giving benefits of low cost, fast response time and ease of service.

These housings are sold singly or in packs of 25.

Principal Specifications

Housing Model	707N	707NC	770N	770NC	778N	778NC
Port Size - NPT	1/4"	1/4"	1/4"	1/4"	1/4"	1/4"
Drain - NPT	1/8"	1/8"	1/8"	1/8"	1/8"	1/8"
Maximum Pressure - Bar	7	7	7	7	7	7
Maximum Temperature - °C	50	50	50	50	50	50
Materials of Construction (1)						
Head & Internals	Nylon	Nylon	Nylon	Nylon	Nylon	Nylon
Bowl	Nylon	PC	Nylon	PC	Nylon	PC
Gaskets	Nitrile	Nitrile	Nitrile	Nitrile	Nitrile	Nitrile
Principal Dimensions						
A - mm	15	15	15	15	15	15
B - mm	44	44	60	60	60	60
C - mm	90	90	145	145	115	115
D - mm	60	60	85	85	70	70
Volume - cc	60	60	135	135	115	115
Weight - kg	0.10	0.10	0.25	0.25	0.20	0.20
Accessories						
Gasket Set	GN707	GN707	GN770	GN770	GN770	GN770
Filter Element Codes						
Coalescing Element	12-25-80C	12-25-80C	25-35-80C	25-35-80C	25-35-80C	25-35-80C
Particulate Element	12-32-60K	12-32-60K	25-30-60K	25-30-60K	25-30-60K	25-30-60K

Note (1) Material abbreviation, PC = Polycarbonate

Aluminium Housings

Anodised aluminium construction
 Aluminium or polycarbonate bowls
 Low cost design
 Choice of 2 or 3 ports
 Ideal compressed air filters

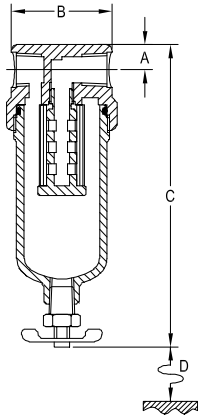

Headline 200 series aluminium and aluminium/polycarbonate housings are extensively used in applications where non-corrosive gases are filtered. Housings are available with no drains for particulate removal and with manual drains for coalescing applications.

Principal Specifications

Housing Model	210	213	210A	213A	210AL	213AL	235	235A
Port Size - NPT	1/8"	1/4"	1/8"	1/4"	1/8"	1/4"	1/4" or 1/2"	1/4" or 1/2"
Drain	Manual	Manual	Brass	Brass	Brass	Brass	Brass	Brass
For housing without drain order	200	203	200A	203A	203AL	205AL	-	-
Maximum Pressure - Bar	10	10	16	16	16	16	10	16
Maximum Temperature - °C	50	50	120	120	120	120	50	120
Materials of Construction (1)								
Head	AL	AL	AL	AL	AL	AL	AL	AL
Internals	Nylon	Nylon	Nylon	Nylon	Nylon	Nylon	AL/SS	AL/SS
Bowl	PC	PC	AL	AL	AL	AL	PC	AL
Gaskets	Nitrile	Nitrile	Nitrile	Nitrile	Nitrile	Nitrile	Nitrile	Nitrile
Principal Dimensions								
A - mm	10	10	10	10	10	10	14	14
B - mm	40	40	40	40	40	40	63.5	63.5
C - mm (2)	106 (96)	106 (96)	118 (108)	118 (108)	118 (108)	118 (108)	138	138
D - mm	38	38	38	38	63	63	75	75
Volume - cc	35	35	45	45	45	45	135	135
Weight - kg	0.11	0.11	0.16	0.16	0.16	0.16	0.36	0.47
Accessories								
Standard Gasket Set	GN210	GN210	GN210	GN210	GN210	GN210	GN235	GN235
Mounting Bracket	MB110	MB110	MB110	MB110	MB110	MB110	N/A	N/A
Filter Element Codes (3)								
Disposable Element	12-32-xx	12-32-xx	12-32-xx	12-32-xx	12-57-xx	12-57-xx	25-64-xx	25-64-xx
Stainless Steel Element	SS-110-xx	SS-110-xx	SS-110-xx	SS-110-xx	SS-120-xx	SS-120-xx	SS-130-xx	SS-130-xx
PTFE Element	PT-110-xx	PT-110-xx	PT-110-xx	PT-110-xx	PT-120-xx	PT-120-xx	PT-130-xx	PT-130-xx

Notes (1) Material abbreviations, AL = Aluminium, PC = Polycarbonate, SS = 316L Stainless steel
 (2) Figure in brackets is for the housing version without a drain
 (3) Replace 'xx' with grade required, e.g. 12-57-50C, SS-120-25, PT-130-03

Aluminium Housings

Anodised aluminium construction
 Aluminium or polycarbonate bowl
 Low cost designs
 Choice of 2 or 3 ports
 Ideal compressed air filters

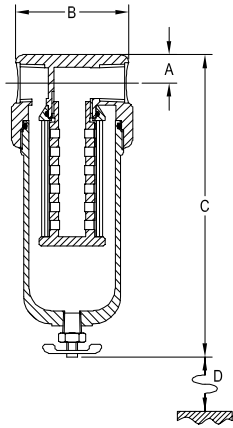

In addition to gas analysis and instrumentation applications, Headline 200 series housings are widely used for compressed air filtration. Coalescing elements are used to filter particulate and water and oil aerosols, while the addition of a final filter with an adsorption cartridge can produce calibration quality air.

Principal Specifications

Housing Model	230	233	230A	233A	250	253	250A	253A
Port Size - NPT	1/4"	1/2"	1/4"	1/2"	1/4"	1/2"	1/4"	1/2"
Drain	Manual	Manual	Brass	Brass	Manual	Manual	Brass	Brass
For housing without drain order	223	225	223A	225A	243	245	243A	245A
Maximum Pressure - Bar	10	10	16	16	10	10	16	16
Maximum Temperature - °C	50	50	120	120	50	50	120	120
Materials of Construction (1)								
Head	AL	AL	AL	AL	AL	AL	AL	AL
Internals	Nylon	Nylon	AL/SS	AL/SS	Nylon	Nylon	AL/SS	AL/SS
Bowl	PC	PC	AL	AL	PC	PC	AL	AL
Gaskets	Nitrile	Nitrile	Nitrile	Nitrile	Nitrile	Nitrile	Nitrile	Nitrile
Principal Dimensions								
A - mm	15.5	15.5	15.5	15.5	15.5	15.5	15.5	15.5
B - mm	62	62	62	62	62	62	62	62
C - mm (2)	162 (152)	162 (152)	162 (152)	162 (152)	265 (255)	265 (255)	265 (255)	265 (255)
D - mm	72	72	72	72	184	184	184	184
Volume - cc	150	150	165	165	300	300	320	320
Weight - kg	0.385	0.385	0.500	0.500	0.465	0.465	0.650	0.650
Accessories								
Standard Gasket Set	GN230	GN230	GN230A	GN230A	GN230	GN230	GN230A	GN230A
Mounting Bracket	MB130	MB130	MB130	MB130	MB130	MB130	MB130	MB130
Filter Element Codes (3)								
Disposable Element	25-64-xx	25-64-xx	25-64-xx	25-64-xx	25-178-xx	25-178-xx	25-178-xx	25-178-xx
Stainless Steel Element	SS-130-xx	SS-130-xx	SS-130-xx	SS-130-xx	SS-140-xx	SS-140-xx	SS-140-xx	SS-140-xx
PTFE Element	PT-130-xx	PT-130-xx	PT-130-xx	PT-130-xx	PT-140-xx	PT-140-xx	PT-140-xx	PT-140-xx

Notes (1) Material abbreviations, AL = Aluminium, PC = Polycarbonate, SS = 316L Stainless steel

(2) Figure in brackets is for the housing version without a drain

(3) Replace 'xx' with grade required, e.g. 25-64-50C, SS-130-25, PT-140-03

Aluminium Inlet Filters

Aluminium & stainless steel construction
 Open & enclosed designs
 Low cost
 Ideal for environment monitoring

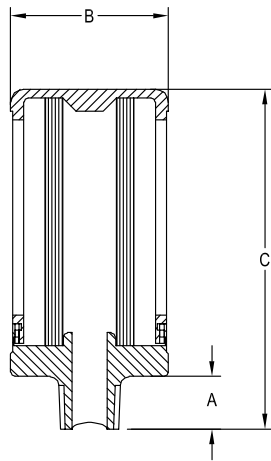

Headline aluminium inlet filters are offered in two versions, open and enclosed. Enclosed versions should be specified if the filter is to be located where it could be damaged accidentally. These filters are extensively used in environment monitoring applications.

Principal Specifications

Housing Model	910	915	920	910E	915E	920E
Port Size - mm or NPT	ø6.3	ø6.3	ø6.3	1/8"	1/4"	1/2"
Maximum Temperature - °C	150	150	150	150	150	150
Materials of Construction (1)						
Head	AL	AL	AL	AL	AL	AL
Cover	-	-	-	AL	AL	AL
Tie Rod	316L	316L	316L	-	-	-
Element Retainer	AL	AL	AL	-	-	-
Principal Dimensions						
A - mm	12	12	20	12	12	22
B - mm	19	19	36	36	36	50
C - mm	50	75	91	53	78	92.5
Weight - kg	0.01	0.01	0.05	0.05	0.05	0.15
Filter Element Codes (2)						
Disposable Element	12-32-xx	12-57-xx	25-64-xx	12-32-xx	12-57-xx	25-64-xx
Stainless Steel Element	SS-110-xx	SS-120-xx	SS-130-xx	SS-110-xx	SS-120-xx	SS-130-xx
PFTE Element	PT-110-xx	PT-120-xx	PT-130-xx	PT-110-xx	PT-120-xx	PT-130-xx

Notes (1) Material abbreviations, 316L = 316L Stainless steel, AL = Aluminium
 (2) Replace 'xx' with grade required, e.g. 12-32-60K, SS-120-10, PT-130-03

Catch Pots

Remove large slugs of water
Prevent filter element flooding

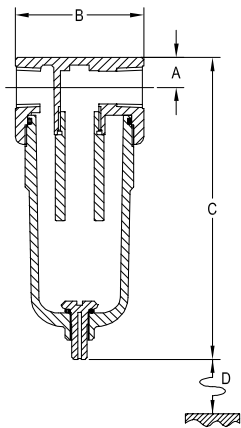

137GCP

A major problem in many gas sample systems is the presence of large quantities of condensed liquid. In such systems it is possible for a filter to become flooded, even when serviced frequently. A common solution to this problem is the installation of a catch pot immediately before the filter. Many Headline filter housings can be converted into catch pots, those with transparent bowls (e.g. 137G, 250, 751N or 780PC) being especially suitable, as they allow continuous monitoring of the liquid level.

To order catch pots simply add CP to the housing code.

Bubblers

Wash gas samples
Add vapour to sample

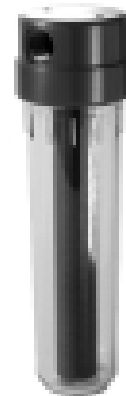
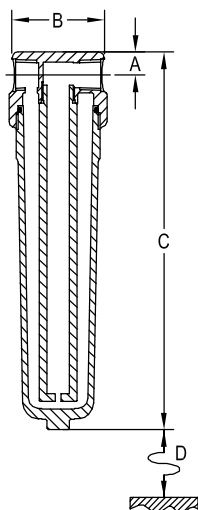

245BB

A further adaption of the filter housings converts them into bubblers, which allows a gas sample to be passed through a liquid. In some applications this will be to wash out or remove an unwanted constituent of the sample, while in others it will be to add a vapour to the sample e.g. to maintain a minimum relative humidity. Many Headline filters can be converted into bubblers, those with transparent bowls (e.g. 250, 751N or 780PC) being especially suitable, as they allow continuous monitoring of the liquid level.

To order bubblers simply add BB to the housing code.

Air Flow Rates in Nm³/hr at stated line pressure and 0.1 Bar Pressure Drop

Filter housings using 12-32-xx, SS-110-xx or PT-110-xx size filter elements

Filter Element Grades

Air Pressure (Bar)

Disposable	SS	PT	0.1	1	2	4	7	10	16	100	200	400	700
40, 40K, 40S	01	-	0.7	1.3	2	3.3	5.3	7.3	11	67	135	225	450
50, 50K, 50S, 50C	03	03	1.4	2.6	3.9	6.4	10	14	22	130	260	440	880
60, 60K, 60S, 60C	10	10	3.9	7.0	11	18	28	39	60	350	700	1200	2400
70, 70K, 70S, 70C	25	25	5.3	9.5	14	24	38	52	81	480	960	1620	3240
80, 80K, 80S, 80C	100	-	5.9	11	16	27	43	60	92	550	1090	1850	3700

Filter housings using 12-57-xx, SS-120-xx or PT-120-xx size filter elements

Filter Element Grades

Air Pressure (Bar)

Disposable	SS	PT	0.1	1	2	4	7	10	16	100	200	400	700
40, 40K, 40S	01	-	1.2	2.3	3.4	5.6	9	12	19	115	225	385	770
50, 50K, 50S, 50C	03	03	2.5	4.5	6.7	11	18	25	38	225	450	795	1590
60, 60K, 60S, 60C	10	10	5.1	9.3	14	23	37	51	79	470	940	1590	3180
70, 70K, 70S, 70C	25	25	6.1	11	17	28	45	61	95	560	1120	1900	3800
80, 80K, 80S, 80C	100	-	6.8	13	19	31	50	69	106	630	1260	2130	4250

Filter housings using 25-64-xx, SS-130-xx or PT-130-xx size filter elements

Filter Element Grades

Air Pressure (Bar)

Disposable	SS	PT	0.1	1	2	4	7	10	16	100	200	300	400
40, 40K, 40S	01	-	2.6	4.7	7	12	19	26	40	240	470	645	820
50, 50K, 50S, 50C	03	03	4.8	9	13	22	35	48	75	440	880	1210	1540
60, 60K, 60S, 60C	10	10	8.5	16	23	39	62	85	130	780	1560	2150	2730
70, 70K, 70S, 70C	25	25	10	18	27	44	74	97	150	890	1780	2450	2730
80, 80K, 80S, 80C	100	-	11	19	29	48	77	105	165	970	1970	2690	3400

Filter housings using 25-178-xx, SS-140-xx or PT-140-xx size filter elements

Filter Element Grades

Air Pressure (Bar)

Disposable	SS	PT	0.1	1	2	4	7	10	16	100	200	300	400
40, 40K, 40S	01	-	6	11	16	26	42	58	90	530	1060	1460	1850
50, 50K, 50S, 50C	03	03	9	17	25	42	67	92	140	840	1680	2320	2950
60, 60K, 60S, 60C	10	10	11	20	30	49	79	110	170	990	1980	2720	3460
70, 70K, 70S, 70C	25	25	12	21	32	53	84	115	180	1680	2120	2920	3710
80, 80K, 80S, 80C	100	-	13	23	35	58	93	130	200	1180	2360	3250	4130

Notes

- (1) The above flow rates are for air at 20°C. Flow rates for other gases can be derived from relative viscosity data
- (2) Flow rates are generally proportional to pressure drop. If an initial drop of 0.2 bar can be tolerated flow rates can be doubled

Distributed by:-



© Headline Filters GmbH 2009



Headline Filters GmbH
Alte Rheinhäuser Str. 8
67346 Speyer am Rhein

Germany

Tel.: +49 (0) 6232 24021 Fax.: +49 (0) 6232 24025
 E-Mail: info@headlinefilters.de
 Website: www.headlinefilters.de